

Barton Convertible I-Series

Owner Operation Manual

(with Warranty)

- This Operation Manual provides important instructions for the safe use of Barton Convertible I-Series chairs. Please read this manual carefully and use Convertible I-Series chairs only after you have developed a full understanding about their safe and correct use.
- Do not use the Convertible without first reading and understanding the transfer procedures.
- Keep this manual where you can consult it whenever necessary.
- The information contained in this manual is subject to change without notice.

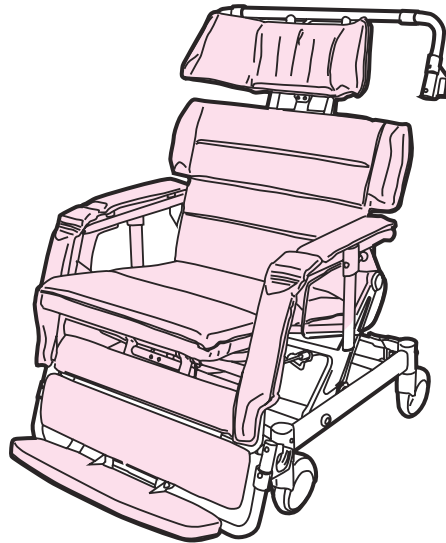

BARTON™
MEDICAL CORPORATION

bartonmedical.com

The Barton™ is a trademark of the Barton Medical Corporation.

WARNING

Do not operate this equipment without first reading and understanding this manual. If you are unable to understand the warnings, cautions, and instructions, contact a healthcare professional, dealer, or technical personnel, if applicable, before attempting to use this equipment. Otherwise injury or damage may result.

SAVE THESE INSTRUCTIONS.

Contents

1	Part Names.....	4
2	Safety Notes.....	5
	- Warnings.....	6
	- Cautions.....	8
3	Making Adjustments.....	10
	- Height/depth/angle adjusting levers.....	10
	- Headrest.....	11
	- Footrest.....	13
	- Leg rest.....	14
4	Operating the Convertible I-Series.....	15
	- Casters.....	15
	- Reclining operation.....	16
	- Side rails.....	18
	- Chair brackets.....	19
5	Troubleshooting the Convertible I-Series.....	21
6	Maintaining the Convertible I-Series.....	21
7	Specifications.....	22
8	Warranty and Service.....	24
9	Limited Warranty.....	25

1 Part Names

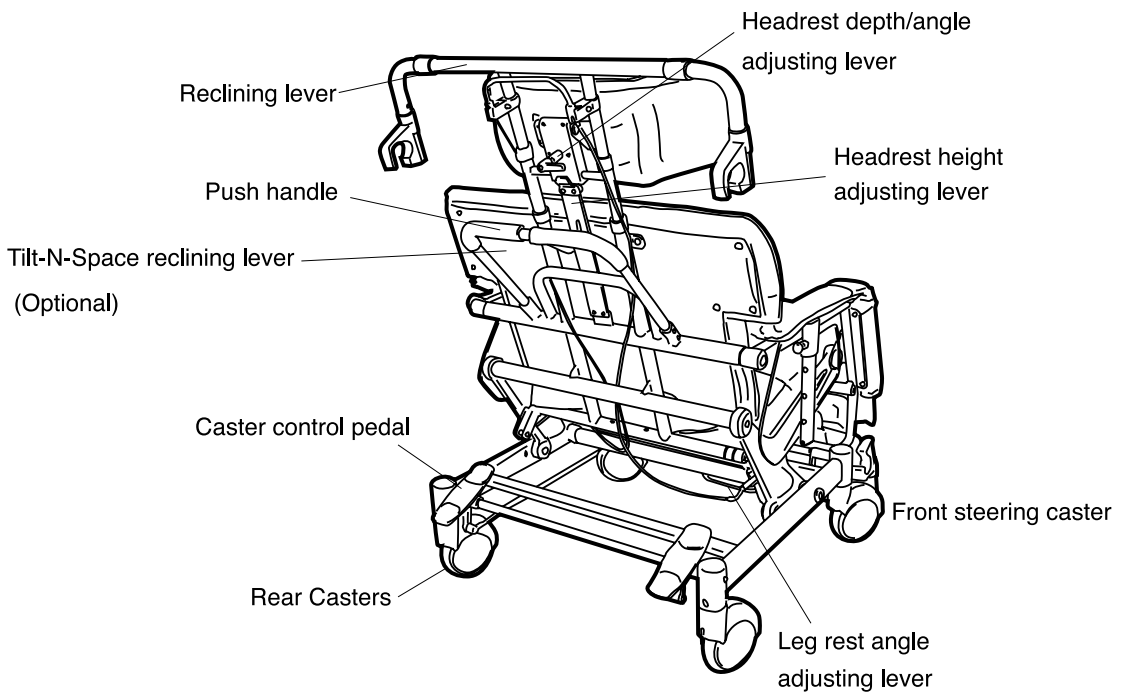
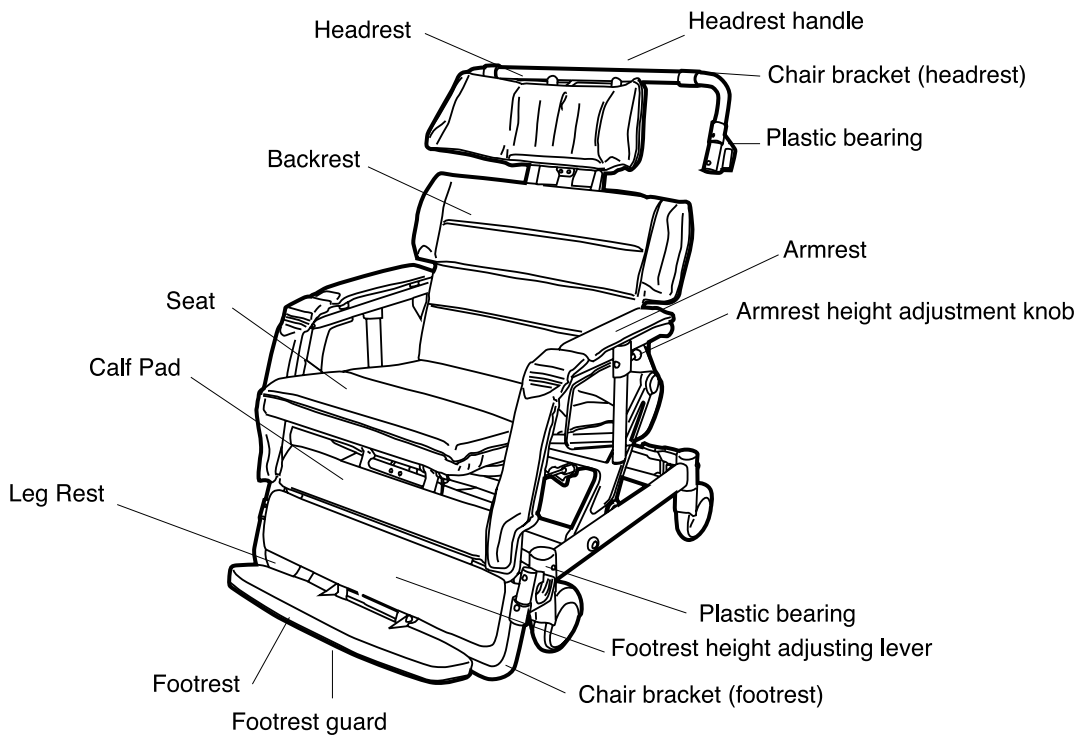

2 Safety Notes

You must understand the warnings and cautions in this manual to use the Barton Convertible safely. Please read all of these instructions carefully to avoid personal injury or property damage.

Tie-Down Restraints and Seat Positioning Straps

The Department of Transportation has not approved any tie-down system for transporting an occupied Convertible in a moving vehicle of any type. The manufacturer does not recommend transporting the Convertible in vehicles of any kind while the equipment is occupied.

It is the manufacturer's position that users of the Convertible should be transferred to appropriate seating in vehicles and be transported with the use of standard auto industry restraints. The manufacturer cannot and does not recommend any transportation system for the Convertible.

As regards to restraints and seat positioning straps, therapists and other healthcare professionals are obligated to determine if a seat positioning strap is required to ensure the safe operation of this equipment by the user. Serious injury can occur in the event of a fall from a Convertible chair.

Weight Limitations

The maximum occupant weight for the Convertible I-220 is 220 lb. The maximum occupant weight for the Convertible I-330 is 330 lb. The maximum occupant weight for Convertible I-660 is 660 lb. People who weigh more cannot use these models.

Some patients' physical limitations or weights present the potential for injuring an attendant or the patient when reclining the Convertible.

When in doubt, ensure that additional attendants are present.

Before using the Convertible, verify that:

1. All casters work properly (4-caster lock, 4-caster free, steering lock).
2. The equipment reclines smoothly and stops in any desired position.
3. The height and angle of the footrest and the height, angle, and depth of the headrest can be adjusted properly.
4. The side rails can be locked and released reliably.

Safety Notes (continued)



WARNING

Please heed the following warning. Failure to observe them can lead to an accident and can seriously the patient.

Warnings

- After any adjustment, repair, or service and before use, ensure that all attaching hardware is tightened securely.



- Do not attempt to move the Convertible in the fully reclined or nearly reclined position.

Do not move!



- Test the recline feature of the Convertible without an occupant to ensure that the locking cylinder is operational. Do not use the Convertible if the locking cylinder is not working properly.



- To maintain maximum stability when reclining/inclining the Convertible, position the patient with arms and legs inside the chair and clear of moving parts.

Inside
Raised armrest



- Do not push or pull the Convertible by the headrest handle.



- Only an attendant should operate the recline mechanism. The occupant must never attempt to recline/incline the Convertible.



Safety Notes (continued)

Warnings

- Do not confuse the headrest and footrest when placing the patient in the prone position.



- Do not jump up and down on the back cushion or seat cushion.

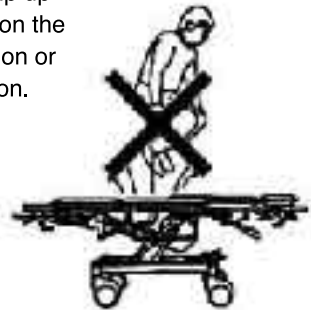

- Do not use stairs or escalators to move an occupied Convertible in any position.

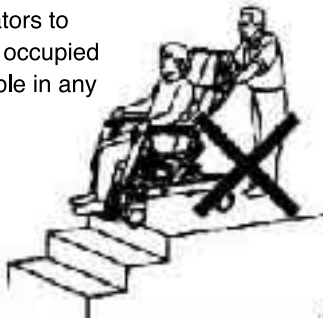

- Ensure that all persons and objects are clear of the Convertible when you recline/incline the equipment.



- Take special care to lock the casters securely.



- Never disassemble or remodel the Convertible.



- The maximum occupant weight for the I-220 is 220 lb., the I-330 is 330 lb., and the maximum for the I-660 is 660 lb. People who weigh more cannot use these models.

- Do not attempt to lift the Convertible I-Series chairs by holding the leg rest assembly.

Safety Notes (continued)

Warnings

- Never sit or lean on the headrest or the legrest when the Convertible is in the prone position.



- Take special care when going up or down a ramp or slope greater than 9°. Never park the Convertible on a slope. And never leave an occupied chair unattended.



- The Convertible is not designed to properly support a patient receiving CPR. This will change the center of gravity and may cause the equipment to tip over.

- Do not use the Convertible on gravel or frozen roads, or any surface that is extremely slick or wet.

Cautions

Please heed the following cautions. Failure to observe them may result in personal injury or mechanical failure.

- Do not attempt to use the caster locks to stop the Convertible in motion. These locks are not designed to be braking devices.



- Do not use the footrest as a step when you sit on or get off of the Convertible.



Safety Notes (continued)

- Always raise the armrests whenever the patient is in the prone position. The armrests act as side rails.



- Do not attempt to move the Convertible by holding the armrest.

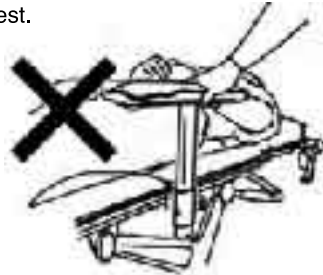

- The Convertible is designed for a single occupant. Never allow two or more people nor place any other heavy object on it.



- Do not use near an open flame (stove, cigarette, etc.) or an extreme heat source.



- When you transform the Convertible from the prone to the sitting position, be sure to do so slowly.

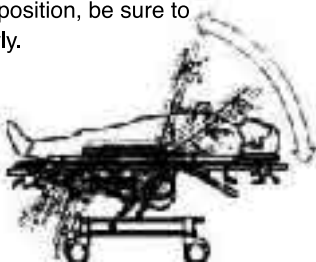

- Never apply any cutter or sharp-edged object to any of the cushions.



- The Convertible I-Series is not designed as a weight training or rehabilitation apparatus. Never use it for such purposes.

- Do not use a Convertible with any missing or abnormal part.

- Use only parts, accessories, and adapters authorized by the manufacturer.

3 Making Adjustments

Height/depth/angle adjusting levers

◆ The Convertible I-Series has three adjusting levers:

1. Headrest height adjusting lever
2. Headrest depth/angle adjusting lever
3. Footrest height adjusting lever

These three levers, which are in the same form, have two functions:

Function 1 Tighten and loosen. (Turn clockwise to tighten and counterclockwise to loosen.)

Function 2 Change lever position in a tightened state.



CAUTION

Do not change the lever position in a loosened state.

1. Turn the lever clockwise. When it is tightened, make the adjustment according to the instructions for the applicable lever.
2. To adjust the headrest depth/angle, push the headrest fully outward and then adjust as in 1 above.

Function 1 Tighten/Loosen

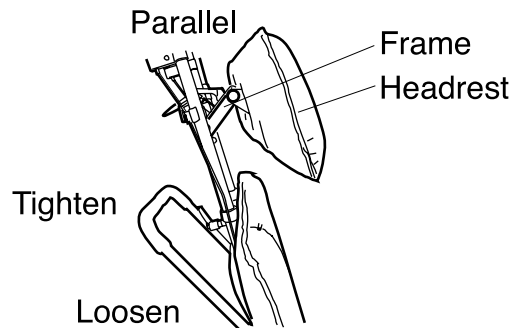

Function 2 Adjust lever position



CAUTION

The lever position cannot be adjusted unless the lever is tightened.

Making Adjustments (continued)

Headrest



WARNING

Always use both hands when raising or lowering headrest. Otherwise an injury or an accident may occur.

Raising the headrest

Hold the headrest handle with one hand. Loosen the headrest height adjusting lever with the other. Then raise the headrest slowly. When the headrest reaches the desired height, tighten the lever fully.

※ At the correct height, the patient's neck is visible.

② Raise

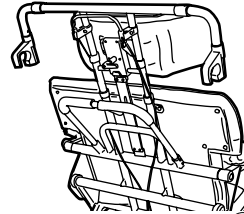

① Loosen

③ Tighten

◆ Depth and angle adjustment

Loosen the lever

Hold the headrest securely in your left hand, so that it doesn't fall abruptly, and loosen the headrest depth/angle adjusting lever by turning it counterclockwise.

Depth/Angle adjustment

Position both the depth and angle of the headrest assembly while the adjusting lever is in its loose position.

Tighten the lever

Once the depth and angle are correctly positioned, secure the headrest in place by turning the adjusting lever clockwise with your right hand while maintaining headrest position with your left hand.

② Push out

① Loosen

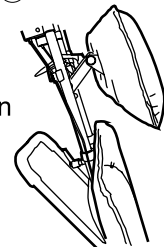

③ Adjust angle

④ Tighten

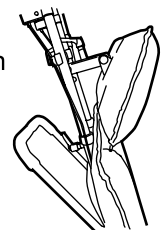

WARNING

When loosening the headrest depth/angle adjustment lever, be sure to hold the headrest securely in place. Loosening the lever with the headrest unsupported may cause the headrest to drop abruptly and an injury or accident may occur.

Making Adjustments (continued)

◆ Support adjustment

Adjusting the headrest support

Hold the middle part of headrest support with one hand and turn one side at a time slowly inward with the other hand.

To return the headrest support to its original position, hold the middle part with one hand and pull one side at a time slowly outward with the other hand.



WARNING

When moving the headrest back to the home position, ensure that nothing comes between the headrest and the chair frame. Otherwise an injury or accident may occur.

◆ Returning headrest to original position

Loosening the lever

Hold the headrest securely in your left hand, so that it doesn't fall abruptly, and loosen the headrest depth/angle adjusting lever by turning it counterclockwise.

② Restore angle/depth to home position.

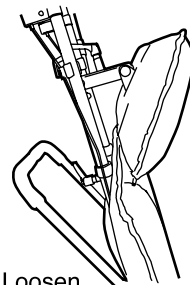

① Loosen

Depth/Angle adjustment back to original position

Position both the depth and angle of the headrest assembly while the adjusting lever is in its loose position. Use both hands to move the headrest back to the original position.

Tighten the lever

Once the depth and angle are correctly positioned, secure the headrest in place by turning the adjusting lever clockwise with your right hand while maintaining headrest position with your left hand.

③ Tighten

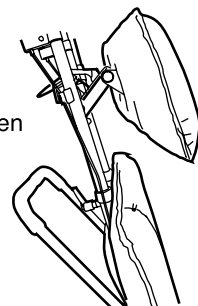

WARNING

When moving the lever back to home position, ensure that nothing comes between the headrest and the handle. Otherwise an injury or accident may occur.

Making Adjustments (continued)

◆ Returning headrest to original position

Lowering the headrest

Hold the headrest handle with one hand. Loosen the headrest height adjusting lever with the other. Then lower the headrest slowly to its lowest position.



WARNING

Be sure to restore the headrest to the lowest position before transforming the Convertible to the prone position. Otherwise the patient's head can get caught between the back and the headrest, thus resulting in an injury or accident.

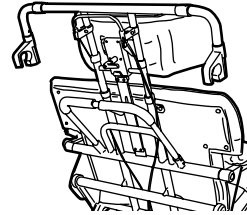

④ Loosen

⑥ Tighten

Footrest

◆ Positioning the footrest

Positioning the footrest for use

Use the footrest only at 0 degrees (in the prone position) and 90 degrees (in the upright position).



WARNING

Never use the footrest at any angle between 0 degrees and 90 degrees. Otherwise the footrest may suddenly fold or rise and cause an injury or accident.



◆ Adjusting the footrest height

When raising and lowering

Hold the footrest guard handle with one hand and loosen the footrest height adjusting lever with the other. Then raise or lower the footrest slowly. When it reaches the desired height, tighten the lever fully.



WARNING

Always use both hands when raising or lowering the footrest. Otherwise an injury or accident may occur.

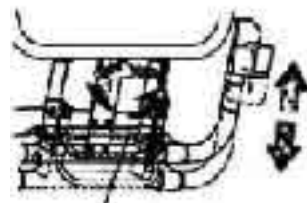

① Loosen

② Adjust height

Making Adjustments (continued)

◆ Adjusting the footrest height



CAUTION

Position the footrest using the footrest height adjusting lever as shown at right. With the lever up, the legrest may not be adjusted properly.

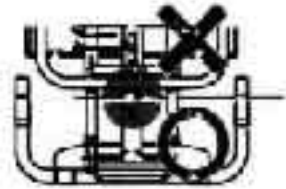

Leg rest

◆ Adjusting the angle of the leg rest

Raising the leg rest

Hold the footrest guard handle with one hand.

Raise the leg rest slowly by holding and pulling the leg rest angle adjusting lever and guard handle together with the other hand.

Release the leg rest angle adjusting lever when the leg rest reaches the desired position.



① Hold

Lowering the leg rest

Hold the footrest guard handle with one hand.

Lower the leg rest slowly until it stops moving by holding and pulling the legrest angle adjusting lever and guard handle together with the other hand.

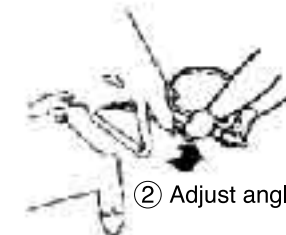

② Adjust angle



WARNING

Always use both hands when raising or lowering the leg rest.



CAUTION

Do not snap the lever; snapping may lead to mechanical problems.

4 Operating the Convertible I-Series

Casters

The casters can be easily controlled by operating the caster control pedal.

◆ Central Lock

Function 1 4-caster lock function

Use this function to hold the Convertible motionless when transforming it from a prone to an upright position and when transferring a patient to and from a bed.



CAUTION

The caster lock is not designed to stop the Convertible in motion. Do not operate the caster control pedal while moving the equipment.

Function 2 4-caster free function

Use this function to bring the Convertible alongside a bed or to "freewheel." This function allows all 4 wheels to swivel and rotate freely.

Function 3 Steering lock function

Use this function to lock the two front casters from swiveling so that the Convertible can be easily steered in a straight line.



CAUTION

Only the two front casters have all three functions. Depress the caster control pedal as shown at right and move the Convertible about three feet backward or forward. This will lock the swivel of the two front casters. You will then be able to move the equipment with greater stability.

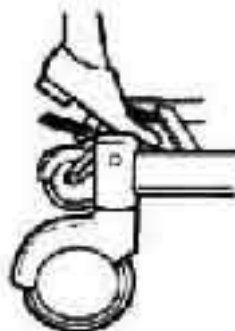

Operating the Convertible I-Series (continued)

Casters (continued)

WARNING

Always use the steering lock function on surfaces with a lateral incline. The Convertible may move in the sloping direction of the incline, when pushed forward, if the chair is in the 4-caster free function. The steering lock function works at the caster angles of 0 degrees and 180 degrees, so that the swivel of the front casters can be locked even when one caster faces forward and the other faces backward. In such a case, set the casters free by using the 4-caster free function, move the chair backward or forward to adjust the caster orientation, and lock the caster swivel again.

Reclining operation

WARNING

Before reclining the Convertible, always ensure that the casters are locked. Otherwise an injury or accident may occur.
Do not transport patients in the reclining position. Otherwise an injury or accident may result.
Before changing the Convertible from the upright to the prone position, be sure to restore the headrest tilt mechanism to the home position. Otherwise the head may drop downward and cause an injury or accident.

CAUTION

Take all reclining steps slowly.
The leg rest must be in the down (lowered) position before reclining/inclining.
The footrest must be in the up (raised) position before reclining/inclining.

Operating the Convertible I-Series (continued)

◆ Changing from sitting to prone position

1. Hold the headrest handle with one hand and squeeze the reclining lever and headrest handle together with the other. Push both slowly downward.



WARNING

Always use both hands when pushing downward.

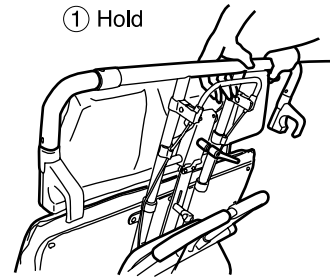

② Push down

2. Release the reclining lever when the back reaches the desired angle.



CAUTION

Do not snap the lever; snapping may lead to mechanical problems.

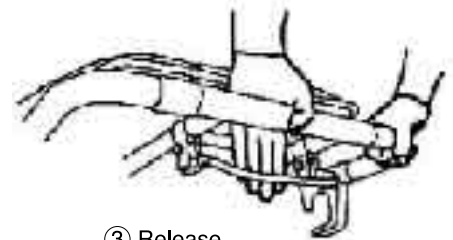

③ Release

◆ Changing from prone to sitting position

※ This reverses the procedure for changing from sitting to prone position.

1. Hold the headrest handle with one hand and squeeze the reclining lever and headrest handle together with the other, and lift them slowly upward.



WARNING

Always use both hands when lifting.

② Lift



① Hold

2. Release the reclining lever when the back reaches the desired angle.



CAUTION

Do not snap the lever; snapping may lead to mechanical problems.



③ Release

Operating the Convertible I-Series (continued)

◆ Changing from prone to sitting position

3. The back stops at any angle between the prone position and the back angle of 70 degrees.

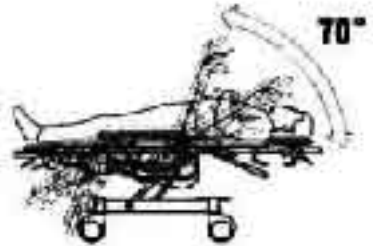

Armrests

◆ How to use the armrests as siderails

Raising the armrests

Pull the armrest height adjusting knob with one hand while simultaneously raising the armrest with the other. Once the side armrest is at the desired height, release the height adjusting knob and armrest will lock into place.

Raising side rails

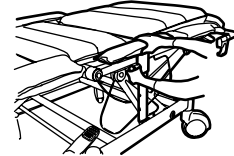

Lowering the armrests

Pull the armrest height adjusting knob with one hand while simultaneously lowering the armrest with the other. Once the armrest is at the desired height, release the height adjusting knob and the armrest will lock into place.

Lowering side rails

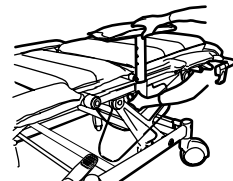

① Pull knob

② Lower

WARNING

Ensure that armrests are securely locked in place. An unsecured armrest may fall abruptly and an injury or accident may occur.

Operating the Convertible I-Series (continued)

Chair brackets

◆ Notes on chair brackets

The chair brackets are installed on each side of the headrest and footrest of the Convertible.

WARNING

Use the chair brackets only when the Convertible is in the prone position. Protruding chair brackets present a great danger; people and objects may get caught on them. After transferring a patient, be sure to restore the chair brackets to their original positions before transforming the equipment to the upright position.

CAUTION

Use the chair brackets only when transferring the patient using the transfer bar. Otherwise mechanical failure may result.

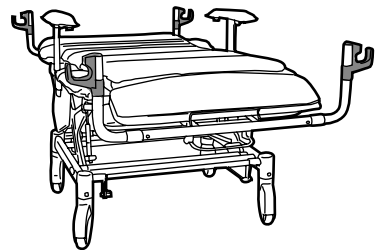

◆ Use of chair brackets

Bringing alongside the bed

Bring the prone Convertible alongside the bed and lock the casters.

Setting chair brackets for use 1

Hold the chair bracket opposite the bed side with one hand and the plastic ring on the guard handle with the other hand. Then turn the chair bracket 90 degrees while pulling the guard handle longitudinally to raise the chair bracket upright.

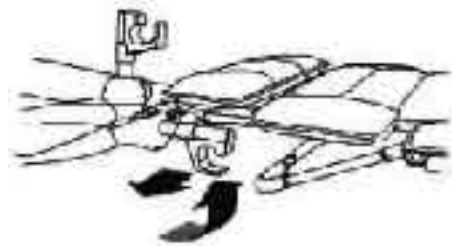

① While pulling

② Turn 90° upward

Operating the Convertible I-Series (continued)

◆ Use of chair brackets

Setting chair brackets for use 2

Now hold the upright chair bracket with one hand and the plastic bearing with the other. Pull and twist the chair bracket away from the bed and release it.

- ※ Perform this operation for both the headrest and footrest chair brackets on the side opposite the bed.

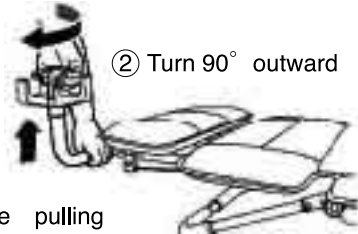

① While pulling



Correct orientation of chair bracket



CAUTION

When restoring the chair brackets to their original positions, always ensure that the plastic bearings are down.

5 Troubleshooting the Convertible I-Series

◆ Trouble? First make these checks.

Before contacting your dealer for repair, please make the following checks:

Trouble	Check	Correction	Page
Does not move	Caster lock	Release caster lock.	15
Does not go straight	Position of caster control pedal	Use the steering lock function of casters.	15
Headrest not locked	Lever position	Correct lever position.	11-13
Angle of leg rest not adjusted	Lever position	Correct lever position.	14

6 Maintaining the Convertible I-Series

Checks and maintenance

1. Checks

Barton Convertible chairs are designed for enhanced safety and durability. Yet they are not totally free from wear and tear resulting from environmental conditions, duration of use, and rough handling. For increased product longevity, periodically inspect all parts and replace them as needed.

2. Maintenance

Moisture can cause rusting and noise. Take care to wipe off any moisture present on the Convertible.

◆ Cleaning the Convertible I-Series

To clean the Convertible, use mild soap and water or a nonabrasive anti-microbial cleanser. First, wet a cloth and wring it dry. Then gently wipe off the chair.



Before using any cleaning product, test it on an inconspicuous area of fabric. Never use any volatile fluid (thinner, gasoline, etc.) that could cause discoloration or deterioration.

7 Specifications

Product name		BARTON Patient Transfer System		
Model:		I-220	I- 330	I-660
Maximum occupant weight:		220 lb	330 lb	660 lb
	Overall length	Fully reclined: 74 in		
	Overall height	Fully upright at lowest headrest position: 52 in Fully reclined: 27.25 in		
	Overall depth	Fully reclined: 47.5 in (footrest down)		
	Overall width	25.6 in	29.5 in	35 in
	Seat width	17.7 in	21.5 in	27 in
	Seat depth	19 in	21 in	24 in
	Net weight	146 lb	152 lb	166 lb
	Shipping weight	168 lb	176 lb	195 lb
	Back angle	0° to 70°		
	Headrest adjustable height	0 to 5 in		
	Footrest adjustable height	0 to 5 in		
Materials	Caster	6 in diameter		
	Frame	1.25 in/1.0 in diameter; steel tubing & aluminum		
	Cushion	Nylon fabric with a blended neoprene/butyl rubber coating (antibacterial) Urethane foam inside		

BARTON CONVERTIBLE I-SERIES CHAIR

LIMITED WARRANTY

PLEASE NOTE: THE WARRANTY BELOW HAS BEEN DRAFTED TO COMPLY WITH FEDERAL LAW APPLICABLE TO PRODUCTS MANUFACTURED AFTER JULY 4, 1975.

This warranty is extended only to the original purchaser/user of our products.

This warranty gives you specific legal rights and you may also have other legal rights, which vary from state to state.

Barton Medical warrants the chair frame to be free from defects in materials and workmanship for a period of three (3) years from date of purchase. Wear items including, but not limited to: upholstery, casters, locking cylinder, release cable, recline release handle, guide rod wear strips, and seat frame wear collars are warranted to be free of defects in material and workmanship for a period of one (1) year. If within such warranty period any such products shall be proven to be defective, such product shall be repaired or replaced, at Barton Medical's option. This warranty does not include any labor or shipping charges incurred in replacement part installation or repair of any such product. Barton Medical's sole obligation and your exclusive remedy under this warranty shall be limited to such repair and/or replacement.

For warranty service, please contact Barton Medical. Do not return products without our prior consent.

LIMITATIONS AND EXCLUSIONS: The foregoing warranty shall not apply to:

- Serial numbered products if the serial number has been removed or defaced;
- Products subjected to negligence, accident, improper operation, maintenance, or storage;
- Products modified without Barton Medical's express written consent including, but not limited to, modification through the use of unauthorized parts or attachments;
- Products damaged by reason of repairs made to any component without the specific consent of Barton Medical; or to
- Products damaged by circumstances beyond Barton Medical's control.

Such evaluation will be solely determined by Barton Medical. The warranty shall not apply to problems arising from normal wear or failure to adhere to these instructions.

THE FOREGOING WARRANTY IS EXCLUSIVE AND IN LIEU OF ALL OTHER EXPRESS WARRANTIES. IMPLIED WARRANTIES, IF ANY, INCLUDING THE IMPLIED WARRANTIES OF MERCHANTABILITY AND FITNESS FOR A PARTICULAR PURPOSE, SHALL NOT EXTEND BEYOND THE DURATION OF THE EXPRESSED WARRANTY PROVIDED HEREIN AND THE REMEDY FOR VIOLATIONS OF ANY IMPLIED WARRANTY SHALL BE LIMITED TO REPAIR OR REPLACEMENT OF THE DEFECTIVE PRODUCT PURSUANT TO THE TERMS CONTAINED HEREIN. BARTON MEDICAL SHALL NOT BE LIABLE FOR ANY CONSEQUENTIAL OR INCIDENTAL DAMAGES WHATSOEVER.

THIS WARRANTY SHALL BE EXTENDED TO COMPLY WITH STATE/PROVINCIAL LAWS AND REQUIREMENTS.

Barton Medical Corporation

5725 Hwy. 290 West, Suite 103, Austin, Texas 78735

Tel: 512-476-7199 Fax: 512-476-7190

E-mail: info@bartonmedical.com

bartonmedical.com